

Track Supply i40 kW 80 / 125 A at 400 / 480 V

Order Numbers Air-Conditioned Units / RAL7035

91008-111-3298726 (80 A, 400 V, RAL 7035 – light grey, Air Condition)
91012-111-3297751 (125 A, 400 V, RAL 7035 – light grey, Air Condition)
91008-111-3298727 (80 A, 480 V, RAL 7035 – light grey, Air Condition)
91012-111-3297752 (125 A, 480 V, RAL 7035 – light grey, Air Condition)

Order Numbers Forced Air Cooled Units / RAL7035

91008-111-3298724 (80 A, 400 V, RAL 7035 – light grey, Forced Air Cooling)
91012-111-3297749 (125 A, 400 V, RAL 7035 – light grey, Forced Air Cooling)
91008-111-3298725 (80 A, 480 V, RAL 7035 – light grey, Forced Air Cooling)
91012-111-3297431 (125 A, 480 V, RAL 7035 – light grey, Forced Air Cooling)

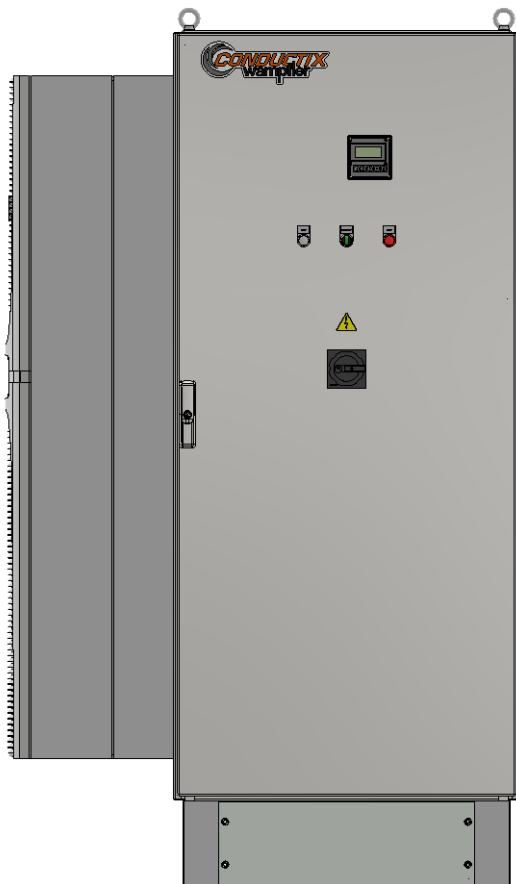

Shown 91012-111-3297751
Air conditioned



Shown 91012-111-3297749
Forced Air Cooling

Track Supply i40 kW

80 / 125 A at 400 / 480 V

Contents

1	Understanding	5
1.1	Limitation of Liability	5
1.2	Copyright	5
1.3	Replacement parts	6
1.4	Material defects	6
1.5	Technical support	6
2	Symbols and Hints	7
3	Advisory Information for the User	8
4	Brief Technical Description	9
5	Appearance and Structure	9
5.1	Type with Air Conditioning.....	9
5.2	Type with Forced Air Cooling	11
6	Technical Data	13
6.1	Electrical Data - Specifications	13
6.1.1	Electrical Output Data – Specifications for 400V and 480V Versions	13
6.1.2	Electrical Input Data – Specifications for 400 V Versions	13
6.1.3	Electrical Input Data – specifications for 480 V Versions.....	13
6.2	Physical Data.....	14
6.2.1	Type without Air Conditioning	14
6.2.2	Type with Air Conditioning	14
6.3	Environmental Data	14
6.4	Mechanical Data.....	16
6.4.1	Dimensions of units with forced air cooling	16
6.4.2	Dimensions of units with air conditioning	17
6.5	Connectors	17
6.5.1	Track connection (X1).....	18
6.5.2	Connection to AC mains supply (X2); Harting HAN K6/6	18
6.5.3	Control and synchronization (X3); Harting HAN 10.....	18
6.6	General Features.....	18

Track Supply i40 kW 80 / 125 A at 400 / 480 V

6.7	Safety Features of Track Supply	19
6.8	Grounding.....	19
7	Configuration Options	20
7.1	Configuration with Air Conditioning Unit (mounted on the side).....	20
7.2	Configuration Operating Frequency	21
7.2.1	Configuration DIP-switches to change the Operating Frequency	21
7.2.2	DIP-Switch Setting Examples	22
8	Control Board Hardware and Failure Indication	23
8.1	Track Supply Display	23
8.1.1	Display	23
8.1.2	Keypad.....	23
8.2	Track Supply Display Message	24
8.3	Track Supply Error Reset	24
8.4	Track Supply Error Codes	25
9	Door Switch	26
9.1	Selection Operating Mode	26
10	Mains Fuses	27
11	Transport and Storage	28
12	Installation	29
12.1	Who is authorized to carry out the Installation?.....	29
12.2	General advice for the Installation	29
12.3	Place and Conditions of Installation	30
12.4	Electrical Regulations	30
12.5	Electrical Connection	31
12.5.1	Mains Connection	31
12.5.2	Configuration of control plug X3.....	32
12.5.2.1	Type of use: bridged	33
12.5.2.2	Type of use: internal 24 V supply.....	33
12.5.2.3	Type of use: external 24 V supply.....	33
12.5.3	Connection Track Cable (X1).....	34
12.5.3.1	Routing of the Connection Track Cable (X1)	34

Track Supply i40 kW

80 / 125 A at 400 / 480 V

12.5.3.2	Adding an extra C-Box (to order separately).....	35
12.5.3.3	Arrangement external connections (X1, X2, X3).....	36
12.5.4	Wiring of the Track Supply X2 and X3	37
13	Warnings and Cautions	38
14	Commissioning	39
15	Start and Operation	40
16	Switching-Off.....	41
17	Actions in case of emergency	41
18	Fault diagnosis.....	42
19	Maintenance	43
19.1	Safety	43
19.2	Maintenance Schedule Track Supply	43
20	Repair.....	45
21	Disassembly/Re-use	46
21.1	Safety advice for disassembly and disposal.....	46
21.2	Recycling.....	46
22	Spare parts	47
23	Tools	48
24	Adjustments during the commissioning and start-up.....	49
25	Inspection Report	50

Important:

Company names mentioned in this manual that are registered and protected trade names by copyright do remain the property of the companies themselves.

We reserve the right to carry out technical modifications of illustrations and statements in these operating instructions, in order to improve the energy supply system and its function.

System related details please find in the system manuals. Refer always to the system documentation before starting any work on the system or components within the system or before operating the system.

Reprint and duplication (as well as extracts) are only allowed with permission from Conductix-Wampfler GmbH.

© Conductix-Wampfler GmbH 2023

Track Supply i40 kW

80 / 125 A at 400 / 480 V

1 Understanding

This document describes the component specified on the cover only. The manual does not include details about the interaction of this component with other matching Conductix-Wampfler GmbH components within a system

For information relating to the system please read the system and project documentation. Follow these instructions during any work on the system or operation of the system.

All given values are based on the metric system. Given dimensions without any measuring unit are generally in millimeters (mm).

The unit supplied may vary of the figures shown depending on the configuration. Please check the version delivered selectively from the operation manual!

1.1 Limitation of Liability

All data and information in these operating instructions have been compiled while taking the valid standards and regulations as well as the state-of-the art and our many years of experience and knowledge into consideration.

Conductix-Wampfler accepts no liability for damage resulting from:

- Failure to comply with operating instructions
- Improper use
- Use by untrained personnel
- Unauthorized modifications
- Technical changes
- Use of unauthorized replacement parts or accessories

The actual scope of delivery may differ from the explanations and descriptions provided here if the model in question is a special one, if additional equipment has been ordered or due to recent technical changes.

The obligations agreed upon in the delivery agreement and our general terms and conditions of business apply, as do the delivery conditions of Conductix-Wampfler and the legal regulations applicable at the time the contract was concluded.

All products are subject to technical modifications, within the context of improvement of function and further development.

1.2 Copyright

These operating instructions are subject to copyright, and exclusively intended for internal use by the customer.

Provision of the operating instructions to third parties, reproductions in any form – even in part – as well as the reuse and/or disclosure of their content are not permitted without the written approval of the Conductix-Wampfler, except for the customer's internal use.

Breach or infringement will result in liability for damages. Our right to further claims remains unaffected.

Track Supply i40 kW

80 / 125 A at 400 / 480 V

1.3 Replacement parts



WARNING!

Incorrect replacement parts are a safety hazard!

Incorrect or faulty replacement parts can impair safety and result in damage, malfunctions or complete failure.

→ Only use original Conductix-Wampfler replacement parts!

Replacement parts can be ordered from an authorized dealer or directly from Conductix-Wampfler.

1.4 Material defects

The terms governing material defects can be found in the General Terms and Conditions of business.

1.5 Technical support

Our customer support staff is available for technical support. See the last page of these operating instructions for contact information.

We are also always interested in new information, experiences and feedback from the field that can help us improve our products.

Track Supply i40 kW

80 / 125 A at 400 / 480 V

2 Symbols and Hints



Warning of voltage

This symbol can be found in several places in the operating instructions where special care has to be taken due to a voltage presence which is hazardous to people. Please observe these instructions and be careful in those cases. Please apply all health and safety regulations to other users as well. Always disconnect the system from the main supply prior to carrying out any work on the energy supply system.



Attention - some hints

This sign draws the attention to parts of the operating instructions where the regulations, advice and correct operational sequence must be observed to avoid any damage or destruction to the energy supply system and its components.



Temperature

This sign draws the attention to parts of the operating instructions, where special care must be taken because of hot surfaces or where inductive heating of ferromagnetic material may occur and where special measures have to be taken.

Please pass on the advice to other users as well.

Track Supply i40 kW

80 / 125 A at 400 / 480 V

3 Advisory Information for the User



When the Track Supply is open it can contain live voltage and hot surfaces, depending on its protection class and state of operation.



Non-permissible removal of required covers, improper operation, faulty installation or operation involve risk of severe injuries to a person and damage to components.



The Track Supply has a weight of approx. 280 kg (Type with Air Cond. approx. 370 kg) and must not be lifted or moved by an individual person. To move and position it use only suitable equipment and follow the according instructions (see chapter 6 "Technical Data").

All electric installation and commissioning work as well as repair work and disassembly have to be carried out by qualified staff (IEC 364 respectively CENELEC HD 384 or DIN VDE 0100 and IEC 664 or DIN VDE 0110 and national safety rules).

All installation and commissioning work as well as repair work and disassembly have to be done according to the present operation manual. The specifications of this document have to be strictly observed. In addition, national regulations and whenever they apply regulations specific to the industry are to be taken into account.

Qualified staff according to the safety regulations are persons who are familiar with the installation, assembly, commissioning and operation of the energy supply system and who have the appropriate qualifications.

Conductix-Wampfler GmbH cannot be responsible for damage or breakdowns that have been caused by not observing the instruction manual.

These operating instructions contain exclusively details of the Track Supply component.

We reserve the right to carry out technical modifications of illustrations and statements in this instruction manual. References to other documents specifying the document number do not include the revision index. Refer to the project handbook for a list of relevant documents.



NOTE!

Tips and recommendations:

This symbol denotes useful tips and recommendations as well as information for efficient and trouble-free operation.

Track Supply i40 kW
80 / 125 A at 400 / 480 V

4 Brief Technical Description



The Track Supply serves to supply energy to the secondary components in system in a defined segment of a i.e., material handling system.

The Track Supply converts the 400 50 Hz or 480 V 60 Hz mains voltage, depending on type, to a constant 20 kHz sinusoidal current. The alternating output current into the primary track of a system produces a local magnetic field over which power is transferred. So, the galvanically isolated power transfer to the consumers is possible (e.g., to the pickups).

5 Appearance and Structure

5.1 Type with Air Conditioning

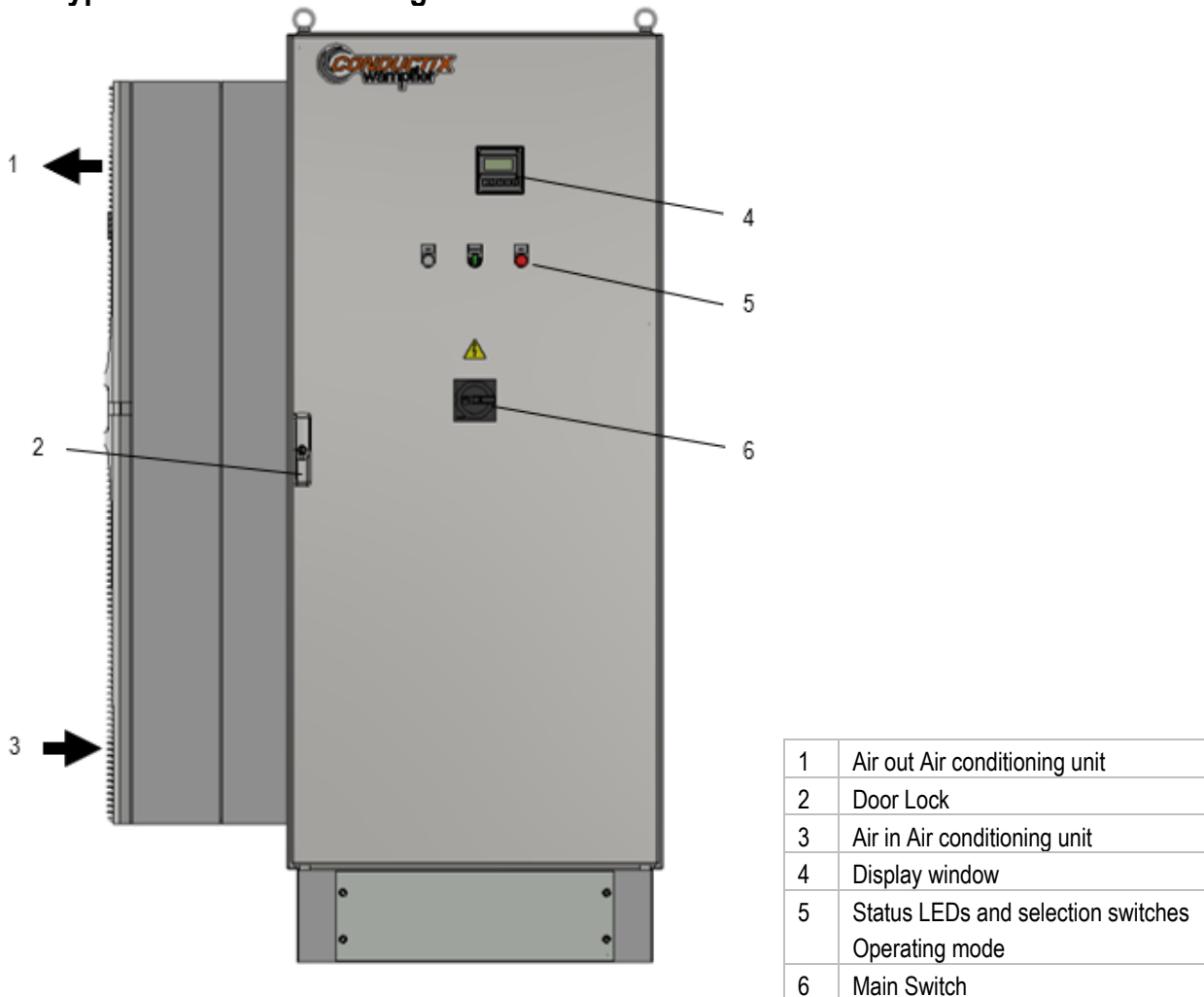

Figure 1: Appearance and main components of Track Supply with air conditioning (Example 91012-111-3297751)

Track Supply i40 kW 80 / 125 A at 400 / 480 V

Regarding the installation place and distances pay attention to the chapter 7.1 “Configuration with Air Conditioning Unit (mounted on the side)”!

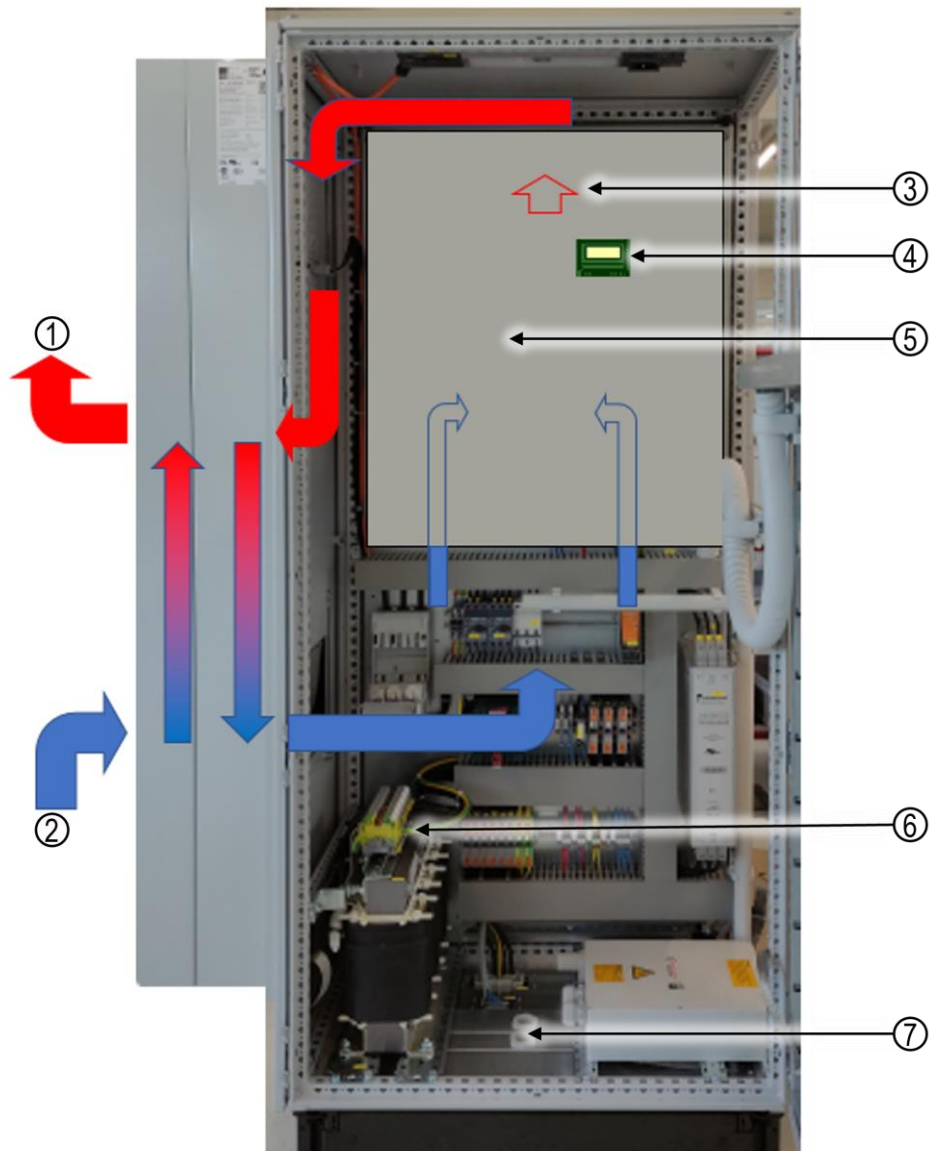

Figure 2: Components inside (photo shows optional C-Box (to order separately))

1	Air out
2	Air in
3	Power module
4	Control board
5	Fan, inside
6	480 V version shown
7	Track cable entry (Litz cable)

Track Supply i40 kW
80 / 125 A at 400 / 480 V

5.2 Type with Forced Air Cooling

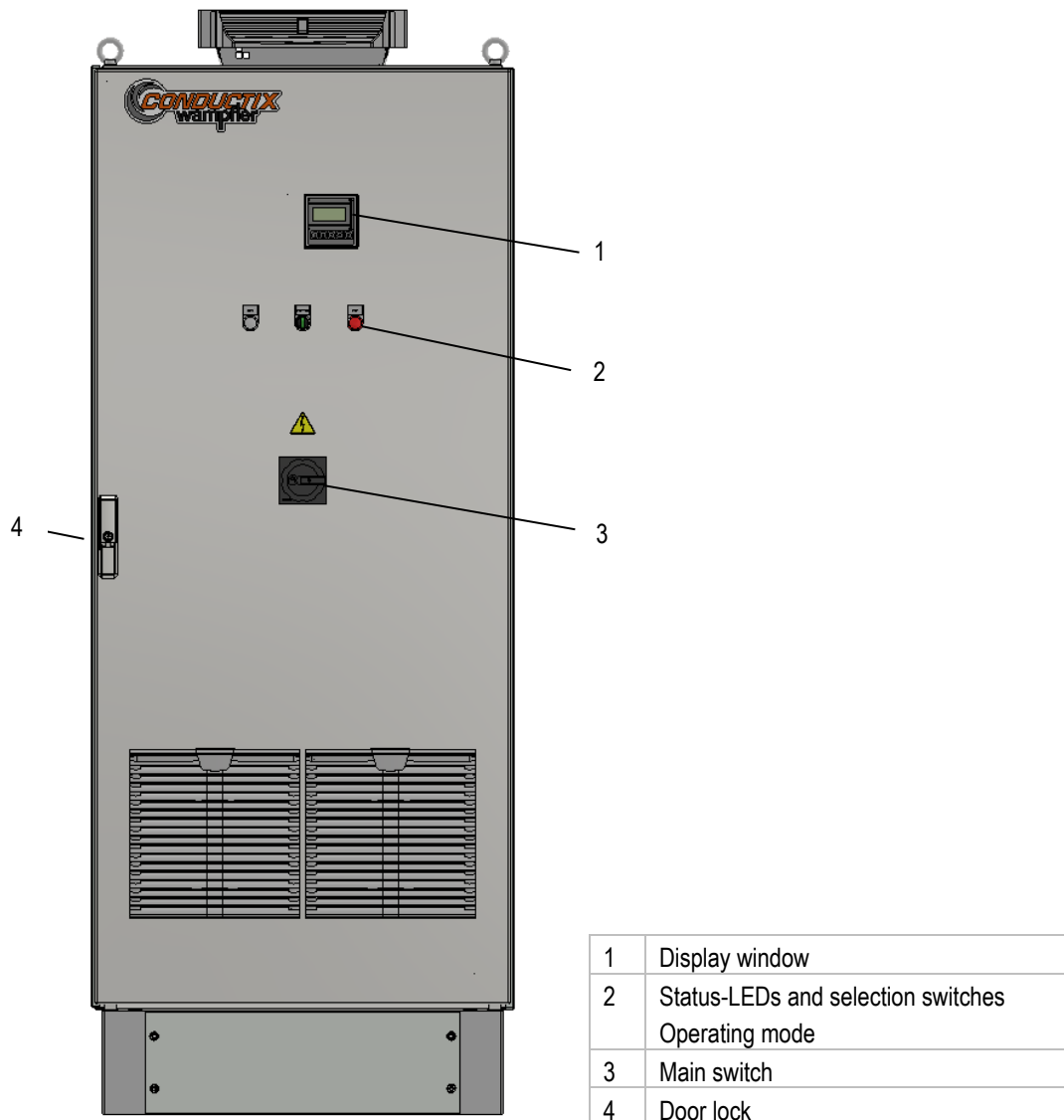

Figure 3: Appearance and main components of Track Supply with Forced Air Cooling

Track Supply i40 kW 80 / 125 A at 400 / 480 V

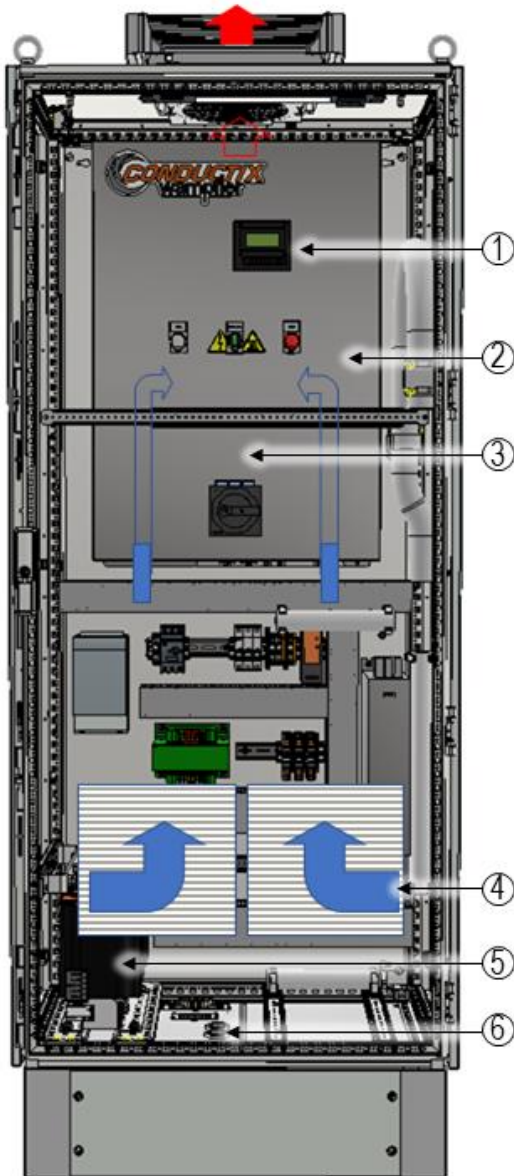

Figure 4: Components inside

1	Control board
2	Power module
3	Fan inside
4	Air in – via front door
5	Version with 480 V transformer shown
6	Track Cable entry (Litz cable)

Note that the picture above may not in some cases correspond exactly to the delivered component (for example color or wiring positions). If you have concerns, you have not been delivered the correct item please contact a Conductix-Wampfler representative.

Track Supply i40 kW

80 / 125 A at 400 / 480 V

6 Technical Data

6.1 Electrical Data - Specifications

6.1.1 Electrical Output Data – Specifications for 400V and 480V Versions

<i>Continuous output power</i>	40 kW
<i>Overload capability</i>	50 kW for max. 1 minute at 40°C
<i>Output current</i>	80A or 125A ± 2 @ 20 kHz ± 50 Hz/60 Hz
<i>Track inductance</i>	for 80 A Track Supply: 3,1 μ H +2% of the total track inductance measured for 125 A Track Supply: 1,6 μ H +2% of the total track inductance measured
<i>Nominal output voltage range</i>	80 A systems: 500 V (625 V) 125 A systems: 320 V (400 V)
<i>Output capacitance to PE</i>	200 nF
<i>Connection to primary cable</i>	Stainless Steel M8 bolts for 35 mm ² and 20 mm ² HF Litz cables. Torque range 9-10 Nm.

6.1.2 Electrical Input Data – Specifications for 400 V Versions

<i>Input supply voltage</i>	400 V / 50 Hz, 3 phase symmetric, neutral grounded
<i>Protection Class</i>	I, grounding mandatory/PE
<i>Overvoltage Class</i>	III
<i>Supply voltage tolerance</i>	+/-10% to + 10%
<i>Input connector</i>	Supplied HAN K6/6 connector with M 40 x 1,5 cable gland. Maximum outside cable diameter is 25 mm. Use flexible cables recommended.
<i>Internal fuses mains supply</i>	100 A NH 1

6.1.3 Electrical Input Data – specifications for 480 V Versions

<i>Input supply voltage</i>	480 V / 60 Hz, 3 phase symmetric, neutral grounded.
<i>Protection Class</i>	I, grounding mandatory/PE
<i>Overvoltage Class</i>	III
<i>Supply voltage tolerance</i>	+/-10% to + 10%
<i>Input connector</i>	Supplied HAN K6/6 connector with M 40 x 1,5 cable gland. Maximum outside cable diameter is 25 mm. Use flexible cables recommended.
<i>Internal fuses</i>	100 A NH 1

Track Supply i40 kW

80 / 125 A at 400 / 480 V

6.2 Physical Data

6.2.1 Type without Air Conditioning

<i>Noise levels</i>	During operation 60 dBA at 2 m distance in front
<i>Air volume moved</i>	800 m ³ / hour (air recirculation)
<i>Fan</i>	1 axial fan

6.2.2 Type with Air Conditioning

<i>Air Conditioning</i>	Air cond. unit type Rittal TopTherm Blue e
<i>Fan</i>	1 axial fan (internal air circulation)
<i>Noise Levels Air. Cond.</i>	During operation 65 dBA at 2 m distance in front

6.3 Environmental Data

<i>Ambient temperature</i>	Forced Air Cooling: +10°C to +40°C, power de-rating 3% / °C between 40°C and 55°C Air Conditioned: +10°C to +45°C, power de-rating 3% / °C between 40°C and 55°C
<i>Humidity</i>	< 90% non-condensing
<i>Ambient air</i>	No salt water, no conductive dry or wet dust! (e. g. carbon fibers). Avoid extreme environment conditions (e. g. very dusty, oily and/or chemical influences)!
<i>Altitude de-rating</i>	1% of power / 100 m above 1000 m, up to a max. of 3000 m above sea level
<i>IP classification</i>	Forced Air Cooling: IP34 (limited by exhaust vents on top) Air Conditioned: IP34/54 (limited by AC-unit specification)
<i>Storage temperature</i>	-20°C to +60°C
<i>Transport temperature</i>	-20°C to +70°C
<i>Maximum vibration</i>	3 mm at 2 - 9 Hz, max. acceleration 0,5 g at 9 - 200 Hz
<i>Maximum operating shock</i>	8 g, 11 ms
<i>Maximum shipping shock</i>	15 g, 11 ms in packaging / transport box

Track Supply i40 kW 80 / 125 A at 400 / 480 V

For correct cooling the Track Supply requires sufficient air flow.

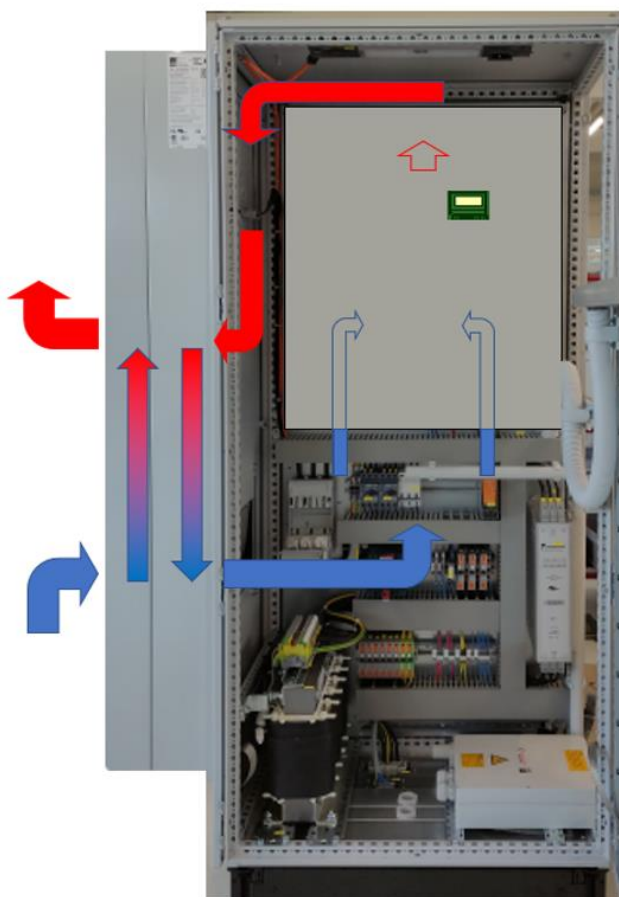

Figure 5: Air flow with Air Conditioning

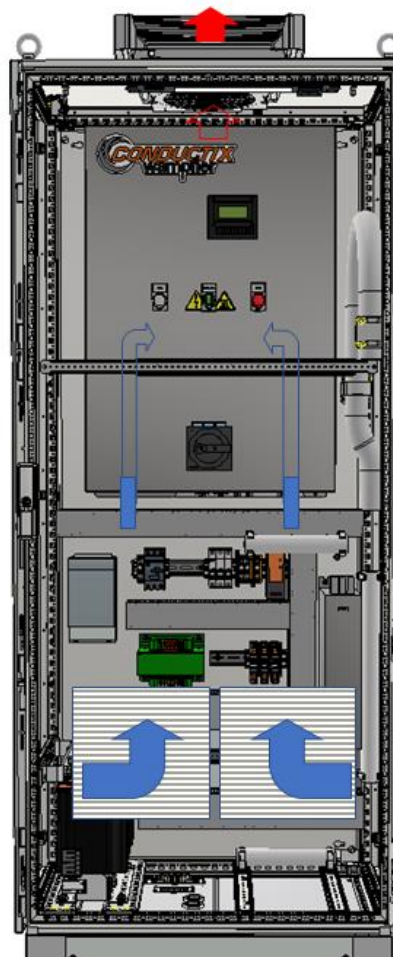

Figure 6: Air flow with Forced Air Cooling

Recommended clearances:

400 mm over the Track Supply

Minimum 1000 mm in front of the Track Supply to access the door

100 mm sides and back of the Track Supply

Ensure free air flow at all times and let inspect filters for dust and oil blockage regularly.

The Track Supply has to be fixed on the floor. Follow the instructions of the cabinet producer (Rittal GmbH & Co. KG, Type VX25).

Shielded control cables are not strictly required but to improve the EMC they are recommended.

In order to avoid induced voltages at 20 kHz, the control cables and other cables should not be run close to the track cable and especially not over distances > 5 m. Shielded twisted pair cable will help reduce the capacitive coupling effect. The shield should be grounded at one end only.

Track Supply i40 kW 80 / 125 A at 400 / 480 V

6.4 Mechanical Data

Cabinet	Rittal VX25 with right-hand hinged front door
Locking	Standard locking for Rittal cabinets Rittal VX25
Hinges	130° opening angle
Dimensions	see the following drawing
Color cabinet (outside)	RAL 7035 "light gray"
Color cabinet (inside)	RAL 7035 "light gray"
Color base	RAL 7022 "umbra gray"
Weight (400 V Forced Air C.)	~ 270 kg
Weight (480 V Forced Air C.)	~ 340 kg
Weight (400 V with Air Cond.)	~ 365 kg
Weight (480 V with Air Cond.)	~ 435 kg

6.4.1 Dimensions of units with forced air cooling

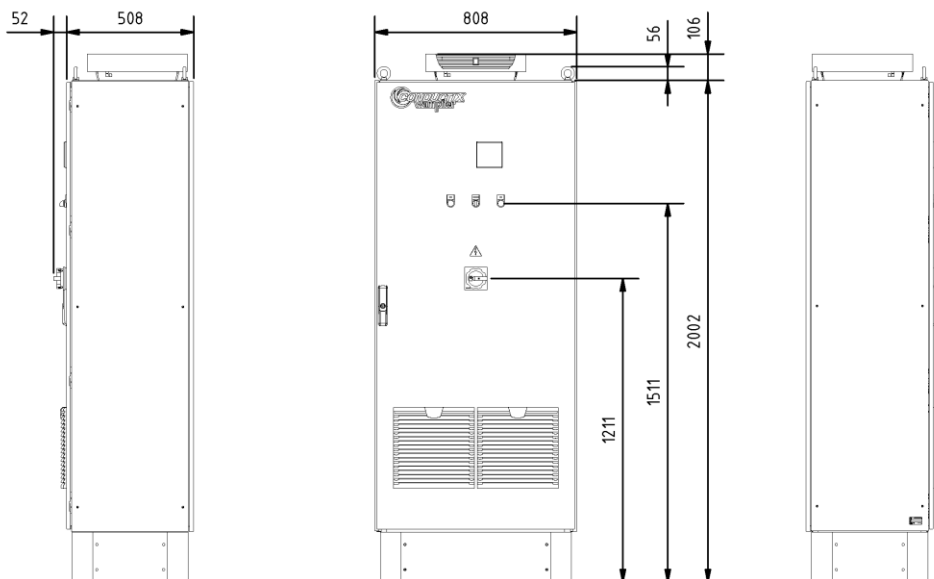

Figure 7: Dimensional drawing (forced air cooling)

Track Supply i40 kW

80 / 125 A at 400 / 480 V

6.4.2 Dimensions of units with air conditioning

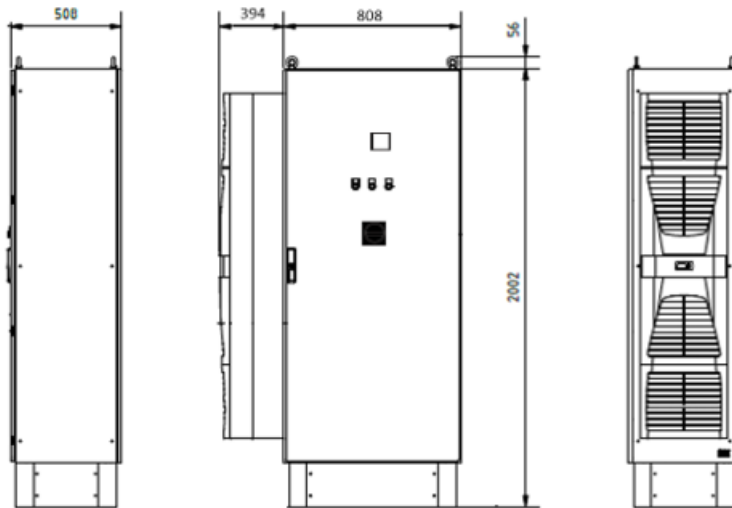

Figure 8: Dimensional drawing (air conditioning, side mounted)

6.5 Connectors



Figure 9: connectors (bottom view)

1	Track connection (X1), see chapter 6.5.1
2	Connection to AC mains supply (X2), see chapter 6.5.2
3	Control and synchronization (X3), see chapter 6.5.3

Track Supply i40 kW 80 / 125 A at 400 / 480 V

6.5.1 Track connection (X1)

Pin	Function	Remarks
1	Track cable 1	Up to 35 mm ² lug soldered HF Litz cable *
2	Track cable 2	

* = cable shoes with M8 hole!

6.5.2 Connection to AC mains supply (X2); Harting HAN K6/6

Pin	Function	Rating	Remarks
1	L1	80 A	I depend on load
2	L2	80 A	I depend on load
3	L3	80 A	I depend on load
PE	PE		

6.5.3 Control and synchronization (X3); Harting HAN 10

Pin	Function	Rating	Remarks
1	Enable +	24 V	24 V present = ready start
2	Enable -	0 V	
3	Status +	24 V	0 V = reset
4	Status NC -	0 V	
5	Status NO -	0 V	
6			
7	Internal mass 0 V	0 V isolated	Required for operating mode and status LEDs
8	Internal mass 0 V	0 V isolated	Required for operating mode and status LEDs
9	Internal +24 V	24 V isolated	Required for operating mode and status LEDs
10	Internal +24 V	24 V isolated	Required for operating mode and status LEDs
PE	PE		

For more details on X1, X2, X3 and their connection refer to chapter 12.5 "Electrical Connection".

6.6 General Features

<i>EMC filtering</i>	Built in line filter included
<i>Start-up inrush current</i>	< 10 A
<i>Mains to output isolation</i>	High frequency isolation transformer
<i>Internal cooling fans</i>	1 axial fan

Track Supply i40 kW

80 / 125 A at 400 / 480 V

6.7 Safety Features of Track Supply

<i>Over temperature</i>	In-built temperature sensors and switches
<i>Overload</i>	Output load monitoring
<i>Over current</i>	Internal current monitoring
<i>Overvoltage on output</i>	Output voltage control
<i>Input to output isolation</i>	2500 V AC for 1 min
<i>Fuses</i>	80 A NH1 (see chapter 22)

6.8 Grounding

The Track Supply must be grounded by technicians at the installation location, to a three-phase grid center earthed. Other connection variants, such as delta grounding, will lead to excessive EMC values and should therefore not be used.

Metal structures which run close and parallel to the primary track cable over significant distances have to be grounded professionally too. For best results multiple grounding should be applied. In order to avoid induced voltages at 20 kHz, the control cables and other cables should not be run close to the track cable and especially not over distances > 5 m. Shielded twisted pair cable will help reduce the capacitive coupling effect, but the shield should be grounded at one end only.

Track Supply i40 kW

80 / 125 A at 400 / 480 V

7 Configuration Options

7.1 Configuration with Air Conditioning Unit (mounted on the side)

The Air Conditioning unit is located on the left side of the track supply. Pay attention to the recommended distances to the neighboring equipment or walls (min. 400 mm) to ensure a free air flow. See chapters:

- 5 „Appearance and Structure
- 6.3 “Environmental Data”
- 12.3 “Place and Conditions of Installation”.

Regarding the operation and maintenance of the Air Conditioning Unit follow the producer documentation. Refer to chapter 22 for the manufacturer's designation.

Recommended adjustment of the temperature for the operation – according to the specified operation conditions: 35 °C

In case an exchange of the Air Conditioning Unit is needed follow the producer documentation and attend to the correct polarity of the connections.

Track Supply i40 kW

80 / 125 A at 400 / 480 V

7.2 Configuration Operating Frequency

As soon as several power supply modules feed into an overall system, transitions between different feed areas are formed. If the power supply modules operate with the same frequency, transitions can occur in these transition zones, leading to a cancellation of magnetic fields. This can result in voltage dips at the output pickups. To ensure a stable and trouble-free operation, the power supply modules of adjacent feed areas must operate with different operating frequencies.

The operating frequency of the power supply module is set via two DIP switches in the power supply module.



Warning!

To avoid damaging and interrupting operations, only Conductix-Wampller service employees may adjust settings.

7.2.1 Configuration DIP-switches to change the Operating Frequency



Important note on DIP switches!

The DIP switches for the power supply module operating frequency were configured during commissioning. When replacing the module, it is essential to ensure that the setting of the DIP switches is adopted for the new power supply module.



The setting can be found in the measurement log of the output loop (table column "DIP-switch") or is to be adopted from the dismantled power supply module.

Setting the operating frequency in the power supply module:

1. Disconnect power supply, wait 10 minutes for internal discharging.
2. Remove the cover (2 fixing screws bottom, 2 fixing screws top, hanged in). Remove cover carefully from the module. Do not touch power electronics.
3. Set operating frequency of the power supply module via the DIP switches S1 and S2.

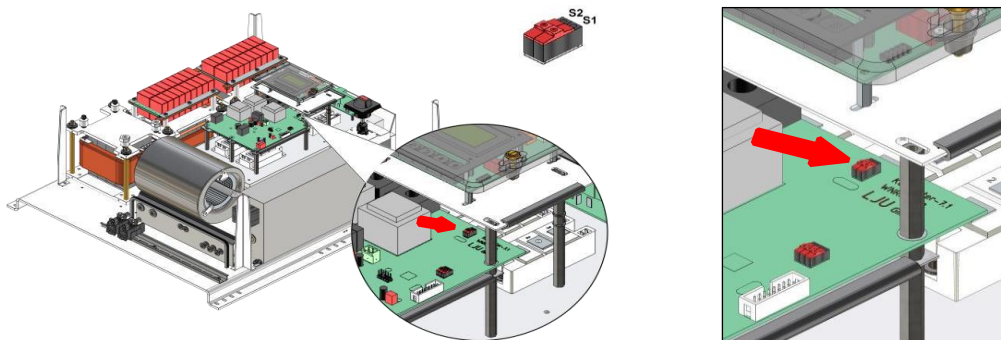

(Figure similar)

4. Place the cover back on the module and close the locks on the right and left of the cover. When placing the cover, ensure that the toggle of the main switch is set to "OFF".
5. Reconnect the PE cable of the cover to a PE terminal of PE.
6. Restore power supply to the power supply module.
7. Turn on main switch on the power supply module.
8. Power supply module frequency setting completed.

Track Supply i40 kW
80 / 125 A at 400 / 480 V

7.2.2 DIP-Switch Setting Examples

System with 4 separately feed Segments – DIP-Switch Settings assure different frequencies at each transfer point.

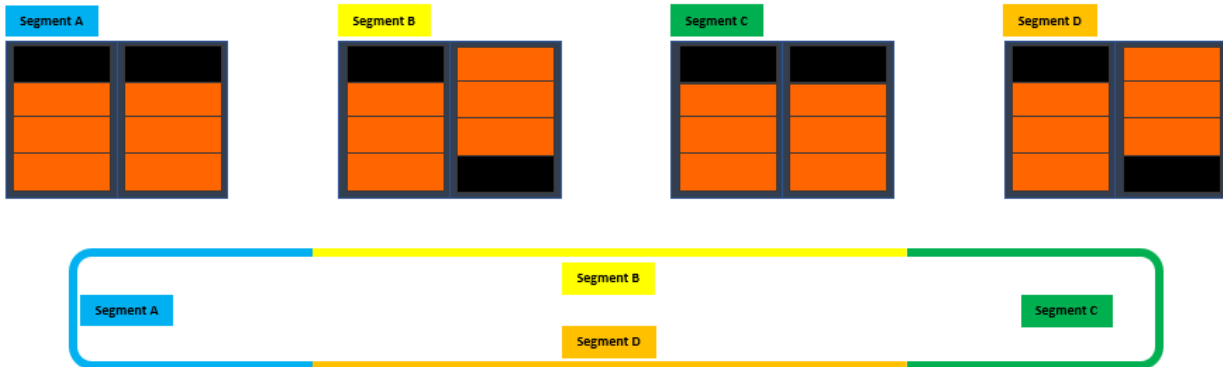

System with 3 separately feed Segments – DIP-Switch Settings assure different frequencies at each transfer point.

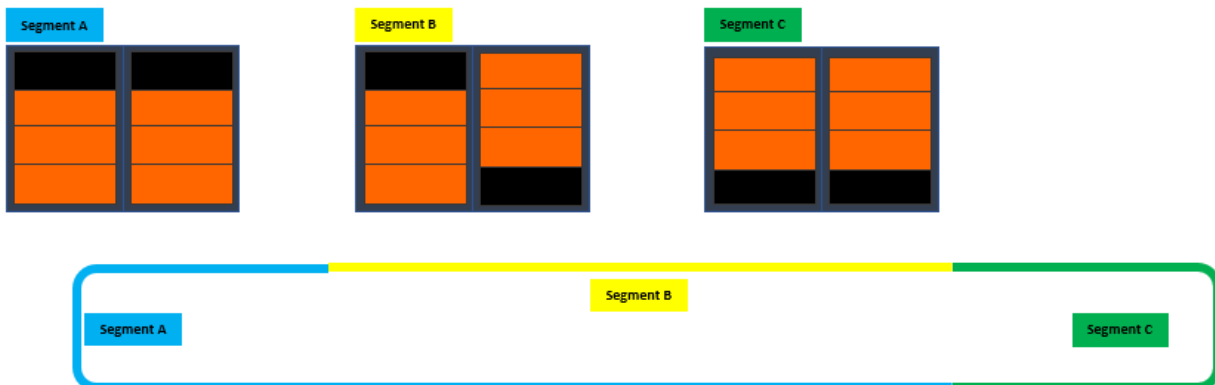

System with 3 separately feed Segments – DIP-Switch Settings DO NOT assure different frequencies transfer C-A



Other Configurations of DIP-switches possible! The above are just examples.

Track Supply i40 kW

80 / 125 A at 400 / 480 V

8 Control Board Hardware and Failure Indication

8.1 Track Supply Display

For displaying operational and error messages and for manual operation, the power supply module has an operating panel (display and keypad).

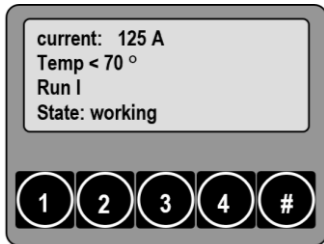

Figure 10: Operating panel (automatic mode, example)

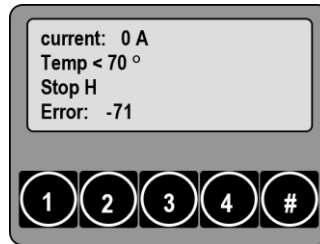

Figure 11: Operating panel (automatic mode, pending error, example)

8.1.1 Display

Display	Value	Meaning
current:	125 A	Actual output current
Temp	< 70 Grad	Operating temperature *
Run	I	Automatic mode
	H	Manual mode
Stop	I	No automatic release
	H	Manual stop
State:	Pre-charge	Pre-charge DC link
	ready	Power supply module ready
	working	Power supply module active
	service	Service jumper plugged in
Error:	-71	Error code of an occurred error

* Display accuracy $\pm 10\%$ - use a suitable clamp meter for a precise measurement of the power loop current.

8.1.2 Keypad

Button	Action
#	Switching between manual/automatic Press the button for at least 2 seconds
1	Stop in manual mode
2	Start in manual mode
3	Not used
4	Not used

Track Supply i40 kW

80 / 125 A at 400 / 480 V

8.2 Track Supply Display Message

If the power supply module has a disorder, the error appears in the display of the power supply module. In the display, if there is an occurred error, the last line "State:" is overwritten with the line "Error:".

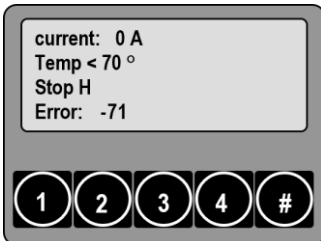

Figure 12: Operating panel (automatic mode, pending error, example)

In addition, a collective error is signaled through the connections X5/29 and X5/30 to the system controller.



Error signaling contacts (NO)!

Closed in error-free automatic mode!

NOTE!

Errors can be hardware-generated or software-generated:

- **hardware-generated:** Errors directly detected by the hardware.
- **software-generated:** Errors detected by evaluation of parameters by the software.

8.3 Track Supply Error Reset

After correcting the cause, errors can be acknowledged in the following ways:

- Switch the power supply module off and back on using the main switch.
- Use the system controller to stop (Stop) and restart (Run) the power supply module.
- Use the keypad to stop (Stop) and restart (Run) the power supply module manually.



Minimum waiting time: 45 seconds!

Wait at least 45 seconds between switching the power supply module off and back on using the door switch or when stopping and restarting the power supply module via the system controller or manually using the keypad.

NOTE!

Track Supply i40 kW

80 / 125 A at 400 / 480 V

8.4 Track Supply Error Codes

Note that one and the same problem can lead to different error codes, depending on the time of occurrence. This is because the error detection methods and reaction times differ for each type of error and also due to the mainly sequential processing by the microprocessor. Once an error is detected, subsequent errors are ignored.

Error codes (HW: hardware-generated; SW: software-generated)		
#	Meaning	Possible causes
1 (SW)	Overheating of inverter Temperature >85 °C ± 5 °C	<ul style="list-style-type: none"> • ambient temperature too high • dirty air filter in control cabinet • fan or air conditioning failure • dirty or defective fan in the power supply module <p>NOTE: To acknowledge the error, switch the power supply module to “Manual” and back to “Automatic”.</p>
2 (SW)	Phase failure of rectifier	missing supply voltage phase
5 (HW)	Overload of Inverter	<ul style="list-style-type: none"> • open or disconnected power loop • compensation error of feed section • defective compensation modules in the feed section • noncompliance with power supply module performance data; check the number of consumers (power pickups) in the feed section <p>NOTE: The inverter automatically restarts after five seconds up to four times successively. If the error does not recur within five minutes, the error counter is reset.</p>
-71 -72 -73 -74 (HW)	Inverter error, output stage A - D	<p>hardware failure</p> <p>NOTE: The inverter will automatically restart after 0.5 seconds. If four output stage errors are detected within two minutes, the inverter will not restart. To acknowledge the error, switch the power supply module off and back on. If the error persists, the module has a hardware failure.</p>
-80 (SW)	Quartz monitoring	<p>20 kHz generation quartz not oscillating</p> <p>NOTE: To acknowledge the error, switch the power supply module off and back on. If the error cannot be acknowledged, the module has a hardware failure.</p>
9 (HW)	Communication error	<p>communication between the keypad and inverter was interrupted for more than 0.5 seconds; this error indicates a hardware failure.</p> <p>NOTE: This code is signaled to the system controller through X3.</p>

Track Supply i40 kW
80 / 125 A at 400 / 480 V

9 Door Switch

The function of the main door switch is to isolate the inverter stage of the Track Supply, thus disconnecting the output from power even when an Enable signal is applied.



Figure 13: Main door switch – shown in "OFF" position (exact orientation of the switch may vary)



If the main switch is placed in the "OFF" position, parts of the Track Supply may still be live. Various types of damage can occur. The standard power shutdown sequence must be carried out as described in section 12.5.1.



Danger to life and limb!

Appropriate safety precautions must be taken.

- Only turn on the Track Supply when the track is connected, and the covers closed.
- Preferably use the enable I/O to switch on and off the Track Supply, after stopping to draw load.
- Work safely: always disconnect the power cable from voltage!

9.1 Selection Operating Mode

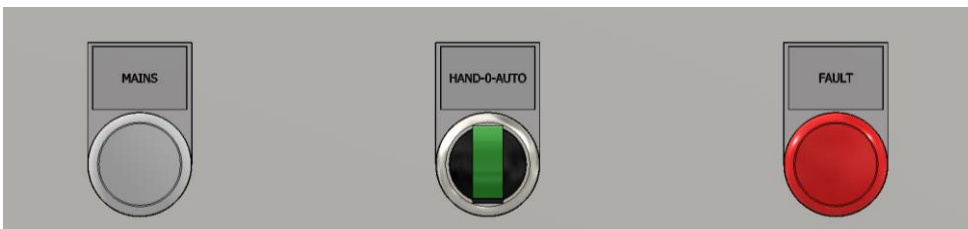

Figure 14: Selection Operating mode

Mode	Position	Description
Hand	Left	Operation local via selector switch (Attention! External release is not taken into account)
Off	Center	Switched off - no operation possible
Automatic	Right	Operation via external release, if bridged continuous operation when switching on the track supply

Track Supply i40 kW
80 / 125 A at 400 / 480 V

10 Mains Fuses

Used fuse see chapter 22.



Attention: The Track Supply is without any voltage inside only when the plug or the power supply is disconnected for at least 20 minutes. After 10 minutes the voltages on the main bus capacitors have dropped to < 60 VDC.

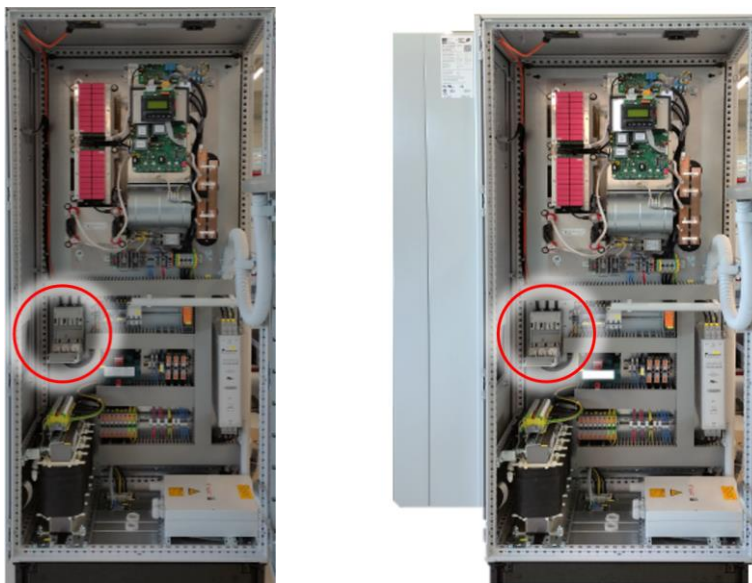
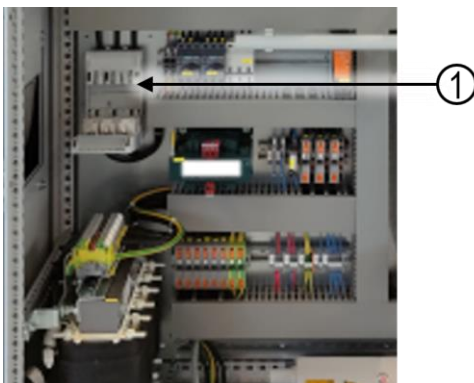

Figure 15: Door open, cover removed: Position switch disconnecter with fuse



- | | |
|---|--|
| 1 | Switch disconnecter w. fuse 3-pole 80A NH1 |
|---|--|

Track Supply i40 kW

80 / 125 A at 400 / 480 V



When checking and changing of the main fuses please follow these instructions:

- Disconnect the Track Supply from power and secure it against being restarted or turned back on.
- Before opening the Track Supply, wait at least 10 minutes to allow internally stored voltage (capacitors) to drop to < 60 V direct current.
- Remove the fuse cover (left cover).
- After removal, check the condition of the fuses!
- If any of the fuses need replacement, change all 3 fuses together.
- Replace the cover and return the Track Supply to operation!
- Connect the Track Supply to the mains voltage and re-start!



The Track Supply may contain other small fuses and circuit-breakers but changing these without consulting Conductix-Wampfler is not recommended.

In case of repair the Track Supply must be disconnected from the mains supply and adequate discharging time (at least 10 minutes to reduce voltages to < 60Vdc) must be observed.

11 Transport and Storage



The transport company must be advised about any damage that has been detected after delivery. Prior to installing or starting operation of damaged components please consult the supplier.

The Track Supply must only be moved, lifted, or carried by suitable lifting and transport equipment (Weight see chapter 6.4 "Mechanical Data"). Pay attention to the additional weight on side.

When using a forklift or similar transport equipment take care not to damage the cabinet. If you move the Track Supply by crane or other lifting equipment, please use the four thread inserts to attach the lifting rope to the Track Supply. Follow the instructions of your lifting gear to lift correctly and safely. Pay attention to the respective equipment operating instructions for lifting and transport.

Regarding storage conditions please see chapter 6.3 "Environmental Data".

Track Supply i40 kW

80 / 125 A at 400 / 480 V

12 Installation

12.1 Who is authorized to carry out the Installation?



All installation and commissioning work as well as maintenance work and disassembly have to be carried out by qualified staff (IEC 364 respectively CENELEC HD 384 or DIN VDE 0100 and IEC 664 or DIN VDE 0110 and national safety rules).



All installation and commissioning work have to be done according to the present operation manual. The specifications of this document have to be strictly observed. In addition, national regulations and whenever they apply regulations specific to the industry are to be taken into account.



Qualified staff according to the safety regulations are persons who are familiar with the assembly and installation of the energy supply system and who have the appropriate qualifications.

12.2 General advice for the Installation



- After receipt of the component(s) and prior to starting the installation work, unpack the component(s) and check carefully for damage that may have occurred during transport or storage (damage to housings and insulation, missing parts etc.).
- Check data on the identification plate to make sure that the component(s) meet the requirements with regard to nominal power and voltage.
- Check completeness of the documents and conformity with the delivered component(s).
- When operating several track supplies in one plant the control board may need to be synchronized. Conductix-Wampller provides documentation with the synchronization components.



For the installation of the Track Supply make sure that it is positioned safely and on an even surface. It has to be secured on site so that the position of the Track Supply will be permanently safe! The Track Supply center of gravity is offset relative to the middle of the base. Follow the cabinet manufacturer's instructions to fix the cabinet on floor. Use only components recommended by the manufacturer to fix the cabinet!

An improper installation of the energy supply system has a negative effect on its function, efficiency and lifetime. It is therefore important to observe the specification for the choice of the place of installation. The guarantee will expire if this is not observed!

Follow the instructions for fixing the cabinet of the Track Supply to the base and make the grounding according to description in chapter 6.8 "Grounding".

Track Supply i40 kW

80 / 125 A at 400 / 480 V

12.3 Place and Conditions of Installation



Always install the Track Supply in a dry and ventilated room. The Track Supply has to be mounted in a vertical position and attached to a solid base or wall construction.



The heat loss of the Track Supply is mainly ventilated out of the housing by forced convection cooling or rather by the Air Conditioning Unit. It is therefore essential to make sure during the mounting that the air flow is not hindered in any way by objects near the inlet or outlet of the housing – see chapter 7.1 “Configuration with Air Conditioning Unit (mounted on the side)”.

The ambient temperature should not be lower than 5°C and must not exceed the Conductix-Wampller specification of 40°C. The relative air humidity should be below 90% and there must not be any condensation. Avoid negative influences of the environment.

Operation outside of these conditions can cause changes of the power parameters. (Take notice of chapter 6 “Technical Data”.)

A sufficient air flow must be ensured at any time. The temperature inside the cabinet shall not exceed 40°C.

The climatic conditions for storage and operation according to the specifications have to be observed - see chapter 6.3 “Environmental Data”.

A distance of 100 mm between the sides and the back of the cabinet to walls and other cabinets and a distance of 400 mm from the Air Conditioning Unit is recommended for maximum performance, especially if neighboring equipment is also generating heat.

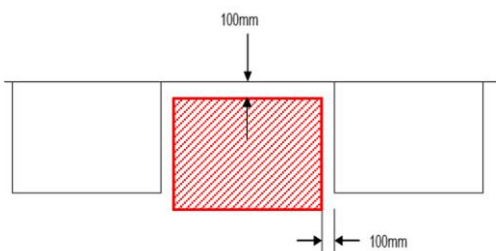

Figure 16: Top view of Track Supply (red) positional placement (Type without Air Cond.)

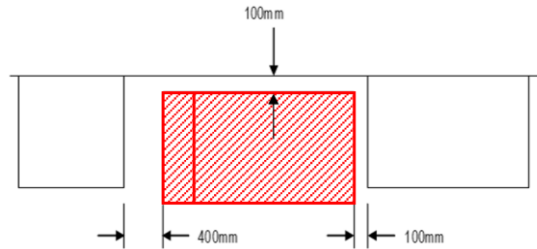

Figure 17: Top view of Track Supply (red) positional placement (Type with Air Cond.)

12.4 Electrical Regulations

The general electrical operating conditions according to VDE 0100 (installation and operation of electrical equipment up to 1000 V) have to be observed. If necessary, observe the local regulations when they go beyond these requirements.

The internal fuses in the Track Supply are for limiting damage within the Track Supply in the event of a component failure. Appropriate protection should be given to the three-phase supply cable according to local regulations.

Track Supply i40 kW

80 / 125 A at 400 / 480 V

12.5 Electrical Connection

12.5.1 Mains Connection

The power cables of the supply lines L1, L2, L3 and PE have to be chosen as follows:

- Use only applicable cables that are approved according to VDE, UL or CUL.
- The Track Supply is designed exclusively for connection to a 3-phase centered earth supply system.
- Grounding is to realize according to VDE, NEC and IEC (see chapter 6.8 "Grounding").
- The 3-phase input supply connection to X2 requires a flexible stranded core type cable for connection to the supplied Harting connector. Maximum cable outer diameter is 25 mm with supplied Pg 29 cable gland. Larger HAN 6 connectors with M40 x 1.5 cable gland entry for larger cables are also available from the manufacturer HARTING. These may be required for cables used in longer cable runs.
- For supply voltages other than specified please consult Conductix-Wampfler.

Attention!

To avoid damaging the input fuses we recommend that the 3 phase mains supply shall be only removed when the START / STOP-signal is in the "STOP" position. A delay of at least 0.5 seconds should always be ensured during regular On/Off switching.

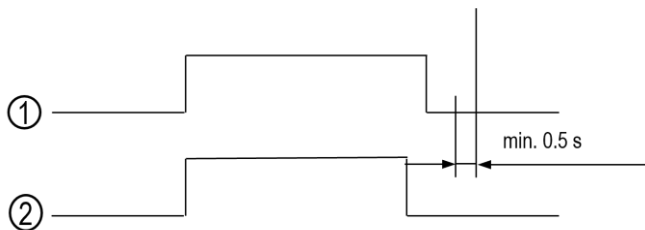

Track Supply i40 kW

80 / 125 A at 400 / 480 V

12.5.2 Configuration of control plug X3

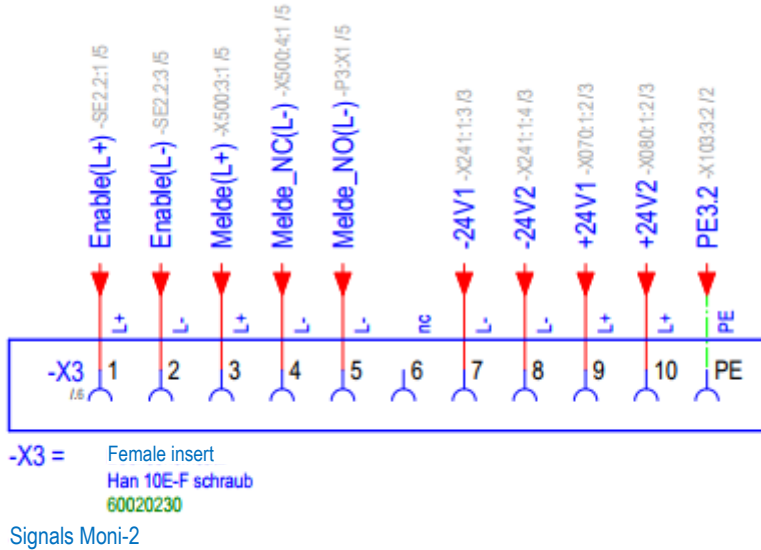



Figure 18: Excerpt from the circuit diagram (X3)

<p>Enable</p>	<p>The Track Supply can only be turned on if the 24 V signal is applied continuously on Pin 1 and Pin 2.</p> <p> Even if no start signal is applied, some parts inside the Track Supply may be live.</p>
	<p> Wiring, use of signals and in case compliance with local standards and regulations is responsibility of the company providing the external wiring!</p>

Track Supply i40 kW
80 / 125 A at 400 / 480 V

12.5.2.1 Type of use: bridged

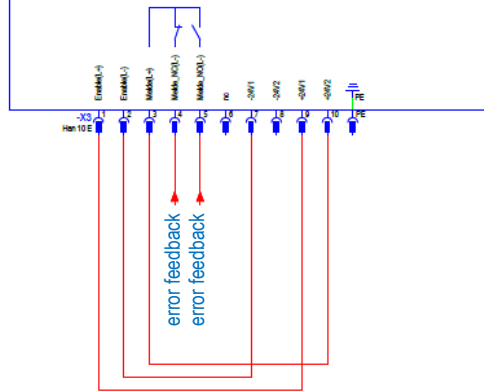

Figure 19: Option 1

12.5.2.2 Type of use: internal 24 V supply

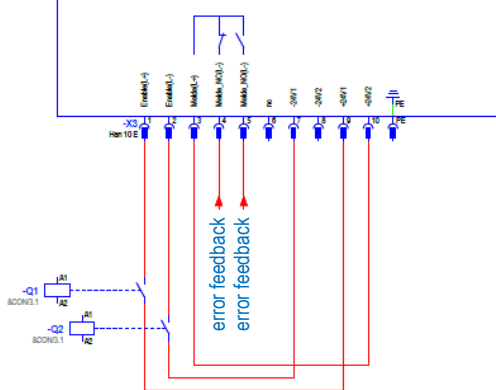

Figure 20: Option 2

12.5.2.3 Type of use: external 24 V supply

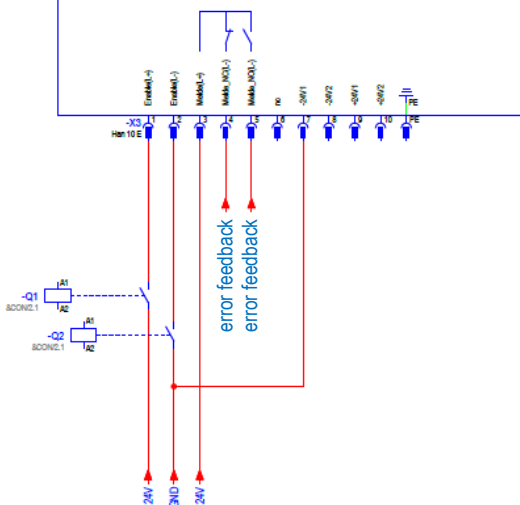

Figure 21: Option 3

Track Supply i40 kW 80 / 125 A at 400 / 480 V

12.5.3 Connection Track Cable (X1)

12.5.3.1 Routing of the Connection Track Cable (X1)

Tightening torque for the X1.1 and X1.2 connection terminals of the track cables: 9-10 Nm

Torque must be checked frequently.

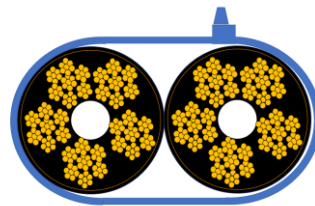
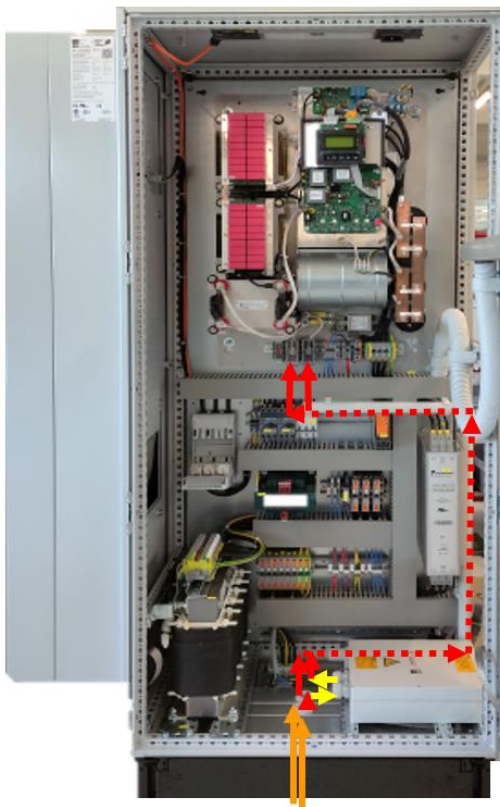

Run Litz Cables tied together closely through the Track Supply wherever possible!

Use cable ties for tying. Don't damage cable insulation while tying cables!

Do plan extra length to route cables through the i40 Track Supplies.

In case of retrofits with short cable tails an extra junction box may become necessary to extend cables. Place the junction box t whether in base or bottom.

Track Supply i40 kW 80 / 125 A at 400 / 480 V

12.5.3.2 Adding an extra C-Box (to order separately)

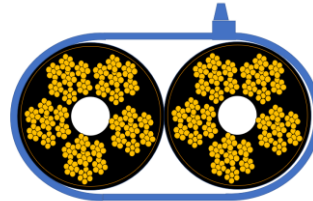
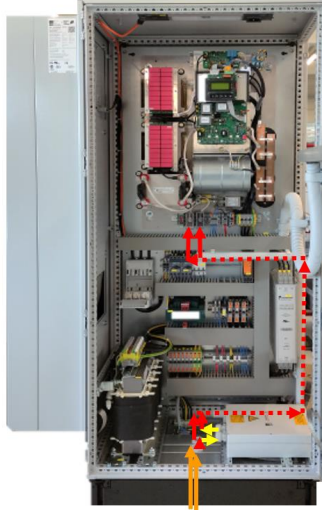

Run Litz Cables tied together closely through the Track Supply wherever possible!

Use cable ties for tying. Don't damage cable insulation while tying cables!

Adding an extra C-Box in the Track Supply, should be considered on an exceptional basis only. Such exception can be i.e., retrofits of Track Supplies set to different track target inductance values. Main target shall always be the LC tuning of systems with C-Boxes along the track. Symmetric placement of C-Box on both cable directions is preferable.

On exceptional basis, asymmetric tuning is acceptable in such Cases!

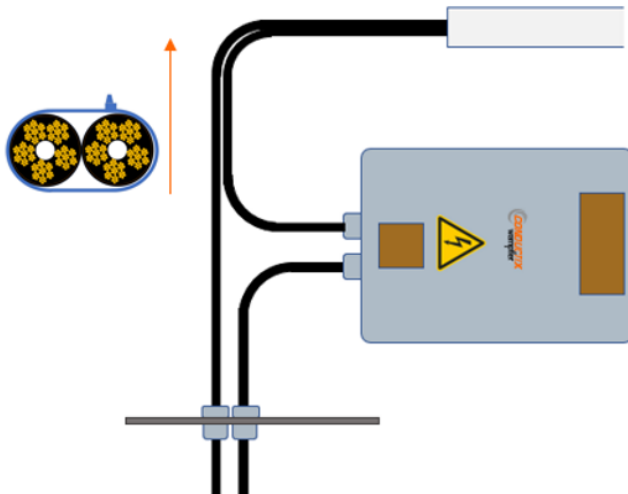

Figure 22: Principle drawing. C-Box to place according to the photo above

Track Supply i40 kW 80 / 125 A at 400 / 480 V

12.5.3.3 Arrangement external connections (X1, X2, X3)

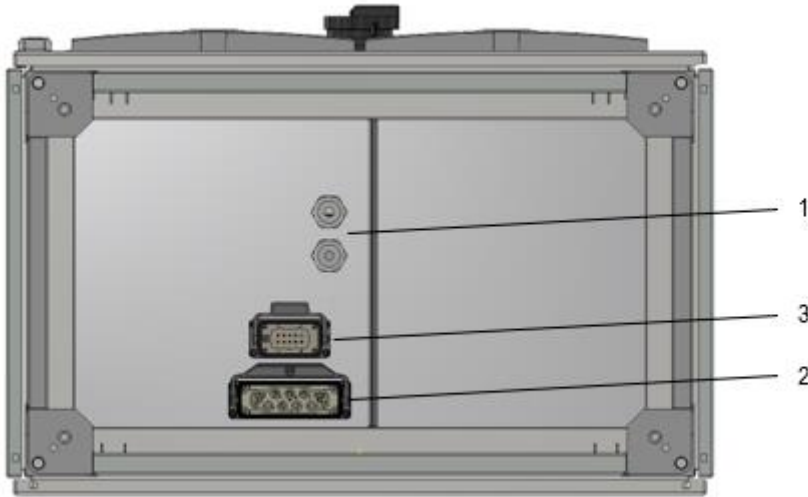

Figure 23: connectors (bottom view)

1	Track connection (X1)
2	Connection to AC mains supply (X2)
3	Control and synchronization (X3)

NOTE: Pay attention to leaving cable ends long enough to make connections. We recommend to use a highly flexible cable!

Track Supply i40 kW
80 / 125 A at 400 / 480 V

12.5.4 Wiring of the Track Supply X2 and X3

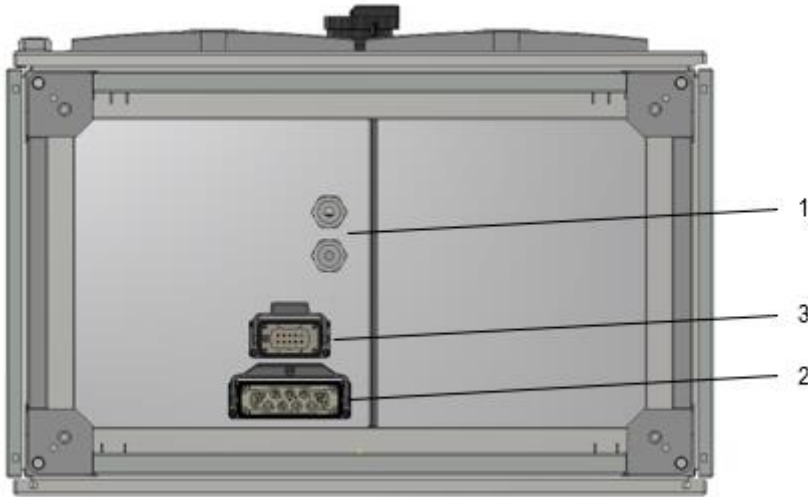
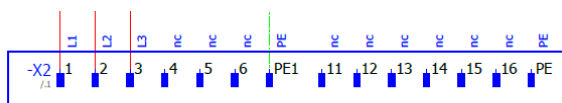

Figure 24: connectors (bottom view)

1	Track connection (X1)
2	Connection to AC mains supply (X2)
3	Control and synchronization (X3)



-X2 = Stifteinsatz
Han K6/6-M crimp
60201179
Einspeisung

Figure 25: Excerpt from the circuit diagram (X2)

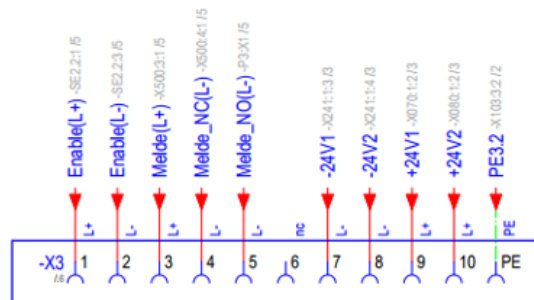

-X3 = Female insert
Han 10E-F schraub
60020230
Signals Moni-2

Figure 26: Excerpt from the circuit diagram (X3)

Track Supply i40 kW

80 / 125 A at 400 / 480 V

13 Warnings and Cautions



All electric works have to be carried out by qualified staff (IEC 364 respectively CENELEC HD 384 or DIN VDE 0100 and IEC 664 or DIN VDE 0110 and national safety rules).



All installation and commissioning work as well as repair work and disassembly have to be done according to the present operation manual. The specifications of this document have to be strictly observed. In addition, national regulations and whenever they apply regulations specific to the industry are to be taken into account.



Qualified staff according to the safety regulations are persons who are familiar with the installation, commissioning, and operation of the energy supply systems and who have the appropriate qualifications.

The Track Supply is only foreseen to be operated in conjunction with matching components by Conductix-Wampfler. If you are not sure whether components match, contact Conductix-Wampfler. Do not put into operation beforehand.

Operation of the Track Supply without all provided covers may allow the ingress of dirt and dust, thereby reducing the ability to function reliably and within specification. Avoid operation with removed cover(s) and / or opened door.

Tighten all cable glands at the bottom of the inner enclosure and ensure that the polycarbonate cover is screwed down properly! All cable connections inside the housing have to be fixed.

Although the Track Supply output is isolated from the mains supply by a transformer, the 20 kHz high frequency output is Protective Earth referenced by Y-connected noise suppressing capacitors. This means a potential voltage exists with respect to PE that could cause electric shock and even death in some people.

Avoid coming into contact with any uninsulated part of the primary supply. Don't touch electrical components in the Track Supply.

DANGER OF LIFE MUST BE AVOIDED BY IMPLEMENTING SUITABLE PROTECTION MEASURES!

Observe safety pre-cautions before and while removing any covers and housings!

Track Supply i40 kW

80 / 125 A at 400 / 480 V

14 Commissioning

Prior to commissioning pay attention to warnings and hints in chapter 13 “Warnings and Cautions”.



Track supplies have to be commissioned in conjunction with other corresponding Conductix-Wampller components. For commissioning it is thus necessary to have the secondary components installed on the vehicles. Access to the secondary side pickups and power regulators on vehicles is necessary.



The primary system has to be installed completely before commissioning. Commissioning on site requires adjustment of the primary track cable impedance that the Track Supply is connected to. The general operation of the inductive energy supply, with regard to the required resonant conditions of the system, is adjusted to the local conditions by means of capacitors and inductors.

These adjustments at the Track Supply must be done only by trained personnel.

During commissioning work the dangerous work zone has to be provided with warning signs and secured with a shutoff tape against entry by unauthorized persons to the site or touching of current-carrying parts.

Requirements for the commissioning:

- Entrance to the site without any problems
- Free access to the power supply without any difficulties
- Free access to all system components
- Safe storage for all needed tools (components, tools, measurement equipment, utilities etc.)
- Possibility to remove or to short-out pickup(s)
- Possibility to increase the load on the pickup(s) / power regulator(s) step by step
- Access to external control signals to the Track Supply

Any changes to the system (e. g. more vehicles) or in the environment after the commissioning require an additional commissioning.

System Protection

The user must install fuses or overload disconnectors in the power input line according to the relevant regulations of the NEC and all local regulations. The operation level must be coordinated with the internal 80 A fusing of the Track Supply.

Track Supply i40 kW

80 / 125 A at 400 / 480 V

15 Start and Operation



The Track Supply is not designed for independent operation. It has to be operated in conjunction with corresponding Conductix-Wampfler components. Therefore, no specific details about the operation are given in this document.



Prior to switching-on the Track Supply ensure that the installation and commissioning were executed correctly. Always attend to the valid safety regulations!

After connecting the Track Supply to the line voltage, the components of the power circuit are connected to the voltage network. Do not touch these components.

DANGER OF LIFE! It is therefore obligatory to keep all doors and covers CLOSED.

Start-Sequence (remote operation):

1. If there is an external isolator switch between net distribution and Track Supply switch it on now.
2. Switch-on the Track Supply - "ON" on the START-input.
3. On the control board the green "ON" LED is on.
4. The system is now on and fully powered.

Prior to any intervention into an electrical or mechanical component of the energy supply system the complete system always has to be disconnected from the supply voltage!

Connecting and disconnecting measuring instruments is only allowed under off-circuit conditions and must only be carried out by trained personnel.

Reconstruction or modifications at the energy supply system or its components on one's own authority are excluded from the guarantee.

Any necessary reconstructions or modifications - especially on electrical components - are only allowed if they have been approved by Conductix-Wampfler.

Track Supply i40 kW

80 / 125 A at 400 / 480 V

16 Switching-Off



As described earlier (see chapter 12.5 “Electrical Connection”): first switch-off the Track Supply by switching the START-input to “OFF” and after this disconnect the line voltage (i. e. by a load switch).



The system should be turned off using the load-break switch only in exceptional cases (see also chapter 9 “Door Switch”).

After disconnection of the energy supply system from the supply voltage, components or power terminals must not be touched immediately afterwards, because capacitors might be charged. Before starting work with the power supply system or its components, wait at least 10 minutes to allow internally stored voltage (capacitors) to drop to < 60 V direct current.

Component lifetime may be extended by turning off the Track Supply when the system is not needed, for instance during the night or on weekends.

17 Actions in case of emergency



In the case of smoke inside the cabinet, sparking or danger to personnel or equipment, immediately disconnect the Track Supply from the main supply by first switching off the isolating switch on the door to “OFF”. As a secondary measure disconnect the HAN K6/6 Power Plug.



Unauthorized switching on by a third person has to be prevented by removing the line fuses of the main supply or by other adequate measures on site.



After turning off the Track Supply, wait at least 10 minutes to allow internally stored voltage (capacitors) to drop to < 60 V direct current **before** opening the cabinet and starting work on the power supply system.

The dangerous zone has to be provided with warning signs and secured with a shutoff tape against entry by unauthorized people.

Track Supply i40 kW 80 / 125 A at 400 / 480 V

18 Fault diagnosis



If the Track Supply faults - e. g. no energy supply to the secondary components, check the LED display for indication of possible cause. Refer to chapter 8 "Control Board Hardware and Failure Indication" for LED status.



Attempts to repair or restart should be avoided! Do not use the system anymore as long as the error is not located and repaired, or defect components are replaced by trained personal!

After conclusion of the failure analysis the Track Supply has to be protected against touching of live parts by closed housing/covers (see Safety hints in chapter 12.2 „General advice for the Installation“).



Figure 27: Position of failure indication on the outside (status lights)

Status lights	
<i>White</i>	Mains: Mains feed active
<i>Green</i>	Track: Track is feed
<i>Red</i>	Fault: Stopped due to faulty conditions

For advanced status analysis see chapter 8 "Control Board Hardware and Failure Indication".

Regarding the failure indication of the Air Conditioning Unit please use the producer documentation of Rittal GmbH & Co. KG.

Track Supply i40 kW

80 / 125 A at 400 / 480 V

19 Maintenance

19.1 Safety



Danger of injury due to improperly executed maintenance tasks!

Improper maintenance can result in serious personnel injury or property damage.

- Before starting work, ensure that there is sufficient space for assembly.
- Maintain order and cleanliness in the assembly area! Loosely stacked or scattered components and tools are a source of accidents.
- If components have been removed, be careful to reinstall them properly, replace all fastening elements, and observe screw tightening torques.



Risk of injury due to insufficient qualification!

Improper use can result in serious injury to persons or property damage.

- All works for installation and commissioning as well as for maintenance and disassembly must be carried out by qualified staff (observe IEC 364 resp. CENELEC HD 384 or DIN VDE 0100 and IEC 664 or DIN VDE 0110 and the national accident prevention regulations).
- All works for installation and commissioning must be carried out according to these mounting instructions. All the notes listed in this document must be strictly observed. It is moreover required to observe the general national prescriptions and specific factory regulations.

Adjustments concerning inductivity may only be made by qualified personnel of Conductix-Wampfler.



Qualified personnel, according to the safety regulations, are persons that are familiar with the installation, assembly, commissioning, and operation of energy supply systems and that have the appropriate qualifications.

19.2 Maintenance Schedule Track Supply

The tasks carried out according to the maintenance schedule must be logged. If regular inspections reveal increased wear, the corresponding maintenance intervals should be shortened in accordance with the actual signs of wear. In case of any questions regarding maintenance tasks and intervals, contact the manufacturer; see service address on the last page.



Danger of electric shock!

During maintenance and repair work the Track Supply must be secured against unexpected and unintended switch on.

- Prior to starting maintenance works disconnect the Track Supply from the mains supply!
- Do not make any structural changes! Always contact Conductix-Wampfler.

Track Supply i40 kW

80 / 125 A at 400 / 480 V

What to check?	How and when?	Actions
Cables, insulation, shock protection	visual inspection at least every 6 months	Repair, secure or replace the cables.
Power supply module for damage	visual inspection at least every 6 months	Repair or replace the module.
Electrical connections	visual inspection tighten connections at least every 6 months	Apply the specified torque. Replace defective terminals and cable lugs.
Internal fan of the power supply module	visual inspection at least every 6 months	Gently clean the fan with compressed air.
Air intake of the power supply module	visual inspection at least every 3 months	Clean, repair or replace filters, fans and air conditioners.
Units on stock	functional test at least annually	Activate module for approx. two hours.



NOTE!

The Track Supply is equipped with a standard filter for normal indoor environment. There are finer filters on the market, if required. We recommend the exclusive use of original filter by Rittal. In very challenging/dirty environment we recommend the installation of an air-conditioned Track Supply IP54.



NOTE!

Generally, it is recommended to apply maintenance at least every 6 months. If the operating conditions are challenging and the environment is not clean, Conductix-Wampfler recommends shorter intervals than 6 months.

For a qualified check of the operating parameters of the system, please contact Conductix-Wampfler. Thus, you can compare the currently measured values with those obtained during commissioning or the last inspection. Here you can also check free airflow inside the housing and specific torques.



WARNING!

Risk of personal injury of property damage!

Improper attachment of the housing cover can cause severe injuries to persons or damage to components.

- After having completed the maintenance and repair works, close the housing covers again, prior to restarting the system.

Track Supply i40 kW

80 / 125 A at 400 / 480 V

20 Repair



If repair action or replacement of faulty parts is necessary and possible on site these works have to be carried out only by trained personnel or by a Conductix-Wampfler technician, both while considering the relevant safety regulations. If no failure analysis or repair is possible on site the faulty part has to be sent to Conductix-Wampfler GmbH. Please inform our service department in this case for details.

To decide which procedure is the best in your case please inform us of the following:

- Product designation
- Material number
- Serial number
- Configuration details (in case)
- Line data (technical and line-specific)
- Wiring scheme of the line / unit (if available)
- Pictures / photos (if available)
- Failure description or details about the malfunction
- Presumption for the failure analysis

The general and local safety regulations have to be observed (see chapter 12 "Installation" and chapter 13 "Warnings and Cautions").

Track Supply i40 kW

80 / 125 A at 400 / 480 V

21 Disassembly/Re-use



If it is necessary to exchange the Track Supply due to damage or to install it in another place, verify that no damage can occur during disassembly.

For installation in another place observe the described mounting and commissioning instructions. Improper application, wrong installation or operation involves the risk of severe injuries to persons and damage to objects.

All electrical work has to be carried out by qualified staff (IEC 364 respectively. CENELEC HD 384 or DIN VDE 0100 and IEC 664 or DIN VDE 0110 and national safety rules).

Qualified staff according to the safety regulations are persons who are familiar with the installation, assembly, commissioning and operation of the energy supply system and who have the appropriate qualifications.

21.1 Safety advice for disassembly and disposal



Avoid any personal and environmental hazard caused by opening of the components!



1. Disconnect unit from the mains voltage.
2. After disconnecting the Track Supply from mains voltage, wait at least 10 minutes to allow internally stored voltage (capacitors) to drop to < 60 V direct current before opening the Track Supply.
3. Dismount the Track Supply.
4. Dispose of components in a specific way. → Recycling (see chapter 21.2)
5. Please pay special attention to the manufacturer's instructions of the air conditioning unit for disassembly and disposal.

21.2 Recycling



The unit contains components that have to be disposed of in a specific way. If it is not used any longer, it needs to be recycled properly.



Please pay special attention to the manufacturer's instructions of the air conditioning unit for recycling.

Track Supply i40 kW

80 / 125 A at 400 / 480 V

22 Spare parts

Only the fuses and a few other parts are to be changed by the operator of the plant! All other parts have to be changed or repaired by trained and qualified Conductix-Wampfler personnel.

Designation	Producer Identification	Conductix-Wampfler Mat.-No.	Used quantity	Remarks
Power Modul 40 kW 125 A 	Conductix-Wampfler only	3301878	1	For 125 A versions only! Replacement only by qualified Conductix-Wampfler personnel
Power Modul 40 kW 80 A 	Conductix-Wampfler only	3301891	1	For 80 A versions only! Replacement only by qualified Conductix-Wampfler personnel
Air Conditioning*	Rittal TopTherm Blue e SK 3189.940	On request	1	Replacement only by qualified personnel
NH1 Fuse 100 A	Different ones	On request	3	Use fuses of same rating and type only.
Other on Request				

*= Spares and wear parts for the air conditioning unit you find in the producer documentation.

23 Tools



Description	Size / specification	Remarks
Open ended or ring spanner wrenches, in case nuts	diff. sizes	Connection track cable (20 and 35 mm ² Litz cable)
Hex Allen Key	4 mm	Plug HAN K6/6
Flat screwdriver	3 - 4 mm	Plug HAN-6HSB and HAN-10E
Cable end sleeves	0.5 – 2.5 mm ²	Plug HAN-10E
Crimper for cable end sleeves	0.5 – 2.5 mm ²	-
Tools to strip the cables	-	-
Side Cutter	-	-

Switching cabinet: For special tools or further details see hints from the producer Rittal GmbH & Co. KG.

Air Conditioning Unit: For special tools or further details see hints from the producer Rittal GmbH & Co. KG.

For the commissioning further tools and measuring instruments are needed.

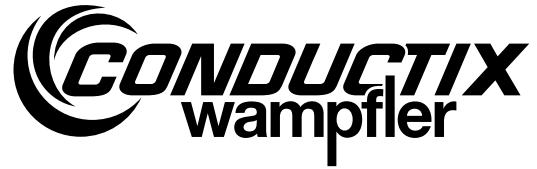

Track Supply i40 kW

80 / 125 A at 400 / 480 V

24 Adjustments during the commissioning and start-up

Track Supply ____ A ____ V @ ____ Hz

Material-No.: _____

Serial number

.....

Name of the project or line

.....

Environmental conditions on the place

.....

Following values were measured or adjusted:

Inductance without track tuning / adjustment (µH)

.....

Inductance after track tuning / adjustment (µH)

.....

Output voltage - track (V)

.....

Output current (A)

.....

Inverter current (A)

.....

Input line supply (V)

.....

Adjusted switch-point Air Conditioning unit

ON..... OFF.....

Remarks / Hints:

.....
.....

Recommended date for the next inspection:

.....
Date

.....
Name

.....
Sign

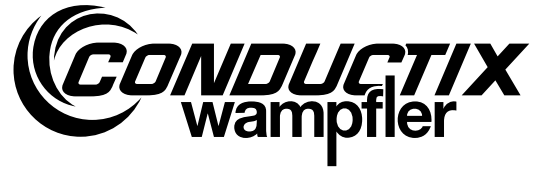

Track Supply i40 kW
80 / 125 A at 400 / 480 V

Inspection Report

Inspection report _____

Track Supply ___ A ___ V @ ___ Hz

Material-No.: _____

Serial number

Name of the project or line

Environmental conditions on the place

Following values were measured or adjusted:

Inductance without track tuning / adjustment (µH) Last Current O.K.

Inductance after track tuning / adjustment (µH)

Output voltage - track (V)

Output current (A)

Inverter current (A)

Input line supply (V)

Adjusted switch-point Air Conditioning unit ON..... OFF.....

Remarks/Hints:

.....
.....

Recommended date for the next inspection:

State of the Track Supply: Ready for operation

.....
Date Name Signature

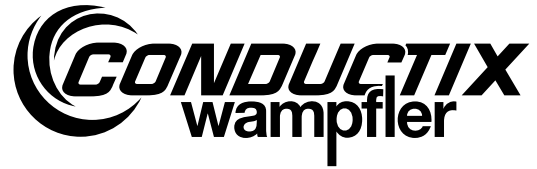

Track Supply i40 kW
80 / 125 A at 400 / 480 V

Inspection Report

Inspection report _____

Track Supply ___ A ___ V @ ___ Hz

Material-No.: _____

Serial number

Name of the project or line

Environmental conditions on the place

Following values were measured or adjusted:

Inductance without track tuning / adjustment (µH) Last Current O.K.

Inductance after track tuning / adjustment (µH)

Output voltage - track (V)

Output current (A)

Inverter current (A)

Input line supply (V)

Adjusted switch-point Air Conditioning unit ON..... OFF.....

Remarks/Hints:

.....
.....

Recommended date for the next inspection:

State of the Track Supply: Ready for operation

.....
Date Name Signature

Operation Manual

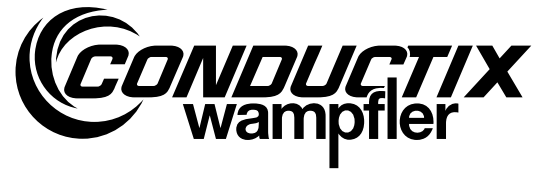

Track Supply i40 kW

80 / 125 A at 400 / 480 V

Conductix-Wampfler GmbH
Rheinstraße 27 + 33
79576 Weil am Rhein - Märkt
Germany

Phone: +49 (0) 7621 662-0
Fax: +49 (0) 7621 662-144
info.de@conductix.com
www.conductix.com



Importer for the United Kingdom:
Conductix-Wampfler Ltd.
1, Michigan Avenue
Salford
M50 2GY
United Kingdom

Phone: +44 161 8480161
Fax: +44 161 8737017
info.uk@conductix.com
www.conductix.com